

e-tron

e-tron 55

November 2021

The Audi e-tron.

Immerse yourself in the exciting world of electromobility with the Audi e-tron and help shape the future. Our first fully electric vehicle, a companion for a new time. This pricelist will make it easy for you to build your e-tron, taking you through all the model and option choices. The online configurator is also available to build your dream car.



Note: vehicle depicted may contain equipment not currently available for the South African market.



Models

| Models | Battery (kW) | Power output (kW) | Torque (Nm) | Electric Consumption combined (WLTP) (kWh/100 km) | CO ₂ emissions (g/km) | Electric range** Combined (WLTP) (km) | 0 – 100 km/h (sec) | Top speed (km/h) | RRP* |
|---------------------|--------------|-------------------|-------------|---|----------------------------------|---------------------------------------|--------------------|------------------|------------|
| 55 quattro advanced | 95 | 300 | 664 | 24.2 - 22.0 (NEDC) | 0 | 369 - 440 | 5.7 | 200 | R1,990,000 |
| 55 quattro S line | 95 | 300 | 664 | 24.2 - 22.0 (NEDC) | 0 | 369 - 440 | 5.7 | 200 | R2,045,000 |

Fuel consumption and CO₂ data applies to the German Market. The specified values are determined in accordance with certain test procedures. The specifications do not refer to an individual vehicle but serve only as a basis for comparing the different types of vehicles. In addition, the consumption figures achieved during normal driving may differ from the test values, depending in particular on special equipment fitted, vehicle loading, personal driving style, road and traffic conditions, environmental factors and conditions of the car.

* RRP is inclusive of VAT, CO₂ emissions tax and a 5 year/100,000km Audi FreewayPlan

** Figures depend on the equipment selected



Standard Equipment: e-tron 55 advanced & S line

Wheels

- ▶ Anti-theft wheel bolts and loose wheel warning
- ▶ Collapsible spare tyre
- ▶ Direct tyre pressure monitoring system
- ▶ Disc brakes in front & rear, 18-inch
- ▶ Tool kit and jack
- ▶ Audi Sport wheels, 5-double-spoke edge style, Matte Titanium grey, diamond-turned, 9.0J x 20, 255/50 R20 tyres (e-tron 55 Advanced only)
- ▶ Wheels, 5-arm turbine style, Graphite grey, diamond-turned, 9.5J x 21, 265/45 R21 tyres (S line only)

Interior equipment

- ▶ 12-volt outlet
- ▶ 4-way lumbar support for the front seats
- ▶ 4-zone climate control system
- ▶ Contour ambient lighting package (multi-colour)
- ▶ Anti-theft alarm system
- ▶ Auto-dimming interior rearview mirror, frameless
- ▶ Comfort centre armrest in front
- ▶ Decorative inserts in graphite grey fine paint
- ▶ Driver and front passenger airbag with front passenger airbag deactivation
- ▶ First aid kit with warning triangle and safety vests
- ▶ Floor mats in front and rear
- ▶ Glossy Black operating buttons with haptic feedback and aluminum look interior
- ▶ Head restraints in front
- ▶ Headliner in fabric, specific color
- ▶ ISOFIX child seat anchors and top tether for the rear bench seat
- ▶ ISOFIX child seat anchors for front passenger seat
- ▶ Leather-wrapped multi-function steering wheel,

3-spoke, with shift paddles

- ▶ Luggage compartment floor mat
- ▶ Manual luggage compartment cover
- ▶ Power front seats with memory feature for driver seat
- ▶ Manual steering wheel adjustment column
- ▶ Seat heaters in front
- ▶ Standard heat output
- ▶ Standard seats in front
- ▶ Stationary air conditioning
- ▶ Storage and Luggage Compartment package
- ▶ Sun visor on driver and front passenger side
- ▶ Upper part of dashboard in leatherette

Safety & Convenience

- ▶ Audi pre sense rear
- ▶ Comfort key with sensor-controlled luggage compartment release
- ▶ Lane change assistant with exit warning system and rear cross traffic alert
- ▶ Luggage compartment lid, electrically opening and closing
- ▶ Parking aid Plus
- ▶ Rear view camera system
- ▶ Seat belt reminder
- ▶ Service indicator 30 000 km or 2 years (fix) electric vehicle
- ▶ Side airbags in front and curtain airbag system
- ▶ With multifunction camera



Standard Equipment: e-tron 55 advanced & S line

Performance & suspension

- ▶ Adaptive air suspension (advanced models only)
- ▶ Adaptive air suspension sport (S line only)
- ▶ Cruise control system with speed limiter
- ▶ Progressive steering
- ▶ quattro

Audio & Communication

- ▶ Audi connect Emergency Call & Service
- ▶ Audi connect Navigation & Infotainment
- ▶ Audi music interface
- ▶ Audi smartphone interface
- ▶ Audi virtual cockpit plus
- ▶ Bang & Olufsen premium sound system with 3D sound
- ▶ Bluetooth interface
- ▶ MMI Navigation plus with MMI touch response

Lighting

- ▶ Separate daytime running light
- ▶ Matrix LED headlamps with dynamic light design and dynamic turn signal

Exterior equipment









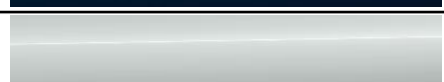

- ▶ Advanced bumpers in contrasting paint (Advanced only)
- ▶ Adaptive windshield wipers with integrated washer nozzles
- ▶ Exterior mirror housings painted in body color
- ▶ Exterior mirrors, power-adjustable, heated and power-folding, auto-dimming on both sides, with memory feature
- ▶ High-gloss styling package
- ▶ Rear spoiler

- ▶ Side and rear windows with heat-reflecting glass
- ▶ S line bumpers in full body paint (S line only)
- ▶ Scuff plates with aluminum inserts in front and rear (Advanced only)
- ▶ Scuff plates with aluminum inserts in front and rear, illuminated, with "S" logo in front (S line only)
- ▶ Windshield with heat-reflecting glass and acoustic glass







Electric specifications

- ▶ e-tron charging system "compact"
- ▶ High-voltage battery 95 kWh (gross)
- ▶ Household plug type M for the e-tron charging system
- ▶ Industrial plug CEE 32 A, 230 V, long and straight, for the e-tron charging system
- ▶ Mode 3 charging cable for public charging 22 kW (AC)
- ▶ On-board charger 11kW (AC)
- ▶ Vehicle charging cable
- ▶ Vehicle inlet CCS type 2
- ▶ Wall bracket



| Paint | | | 55 advanced | 55 S line |
|-------|---|---|-------------|-----------|
| A2A2 |  | Brilliant Black | No cost | No cost |
| Y6Y6 |  | Catalunya Red Metallic | No cost | No cost |
| L5L5 |  | Floret Silver Metallic | No cost | No cost |
| S1S1 |  | Galaxy Blue Metallic | No cost | No cost |
| 2Y2Y |  | Glacier White Metallic | No cost | No cost |
| H1H1 |  | Manhattan Grey Metallic | No cost | No cost |
| 0E0E |  | Myth Black Metallic | No cost | No cost |
| 2D2D |  | Navarra Blue Metallic | No cost | No cost |
| 7M7M |  | Siam Beige Metallic | No cost | No cost |
| 2L2L |  | Typhoon Grey Pearl | No cost | No cost |
| Z7Z7 |  | Chronos Grey Metallic | ---- | No cost |
| 6Y6Y |  | Daytona Grey Pearlescent | ---- | R20,100 |
| Q0Q0 |  | Individual paint finish, Audi exclusive | R72,300 | R72,300 |



| Wheels & Tyres | | | 55 advanced | 55 S line |
|----------------|---|--|-------------|-----------|
| CN7 |  | Audi Sport wheels, 5-double-spoke edge style, Matte Titan. grey, diamond-turned, 9.0J x 20, 255/50 R20 tyres | Std | --- |
| F48 |  | Wheels, 5-arm turbine style, Graphite grey, diamond-turned, 9.5J x 21, 265/45 R21 tyres | R5,100 | Std |
| 47B |  | Wheels, 5-arm turbine style, Black, diamond-turned, 9.5J x 21, 265/45 R21 tyres | R7,100 | No cost |
| F50 |  | Audi Sport wheels, 5-V-spoke star style, Black, 9.5J x 21, 265/45 R21 tyres | R11,100 | R6,200 |
| F51 |  | Audi Sport wheels, 5-V-spoke star style, Platinum grey, diamond-turned, 9.5J x 21, 265/45 R21 tyres | R11,100 | R6,200 |
| 42P |  | Audi Sport wheels, 10-spoke rotor style, Anthracite Black, diamond-turned, 9.5 x 21, 265/45 R21 tyres | R11,100 | R6,200 |
| 54L |  | Audi Sport wheels, 5-spoke structure style, Titanium grey, diamond-turned, 9.5J x 22, 265/40 R22 tyres | R26,100 | R20,600 |



| Optional equipment | | 55 advanced | 55 S line |
|-----------------------------|---|-------------|-----------|
| Styling packages | | | |
| WQS | "S line" interior Includes: - 4-way lumbar support for front seats - Emblems - Headliner in Black fabric - Scuff plates with aluminium inserts in front and rear, illuminated, with "S" logo in front Forces alternative front seats and upholstery at an additional cost | R27,900 | R27,900 |
| 4ZP | Black Appearance package Plus Black styling package with Audi rings at the front and rear and model designation on the rear in black; e-tron lettering on loading flap in black / orange; for S models model designation in the radiator grille in black. Note: can only be ordered in connection with omission of service / technology lettering or omission of model designation and performance / technology lettering | R16,100 | R16,100 |
| 4ZD | Black Styling package Black accents on the exterior in the area of the Singleframe, the trim strips on the side windows and the front and rear bumpers. | R12,000 | R12,000 |
| VJ1 | Bumpers "advanced" in full paint finish | R7,100 | --- |
| 2K8 | S line bumpers in contrasting paint | --- | R40,700 |
| Lighting and Mirrors | | | |
| PXC | Digital Matrix LED headlamps and LED rear combination lamps The headlight technology of the digital matrix LED headlights and LED rear lights makes it possible to project high-resolution light images or animations directly in front of the vehicle. This innovation is complemented by numerous options for adaptive light distribution and light assistance. This can increase comfort when driving in the dark. The customization options for the coming home / leaving home function are based on an extended light show with five selected dynamic projections. | R61,300 | R61,300 |
| 9TF | Door entrance LED projector lights in front and rear | R4,900 | R4,900 |
| 6FJ | Black exterior mirror housings | R2,100 | R2,100 |
| 6FQ | Carbon exterior mirror housings | R13,900 | R13,900 |
| PAF | Virtual exterior mirrors The virtual exterior mirrors produce an impressive effect with the aerodynamic form of the exterior camera mounts and the high-contrast 7-inch OLED displays in the interior. In order to adjust the required field of view, the image section can be moved with user-friendly touch operation. | R23,900 | R23,900 |



| Optional equipment | | 55 advanced | 55 S line |
|---------------------------|--|-------------|-----------|
| Interior equipment | | | |
| 6NQ | Headliner in Black fabric | R6,500 | R6,500 |
| 2C7 | Electric steering wheel adjustment | R8,100 | R8,100 |
| 1XP | Leather-wrapped multi-function sports steering wheel, with shift paddles and steering wheel heating | R3,800 | R3,800 |
| 2ZM | Leather-wrapped multi-function steering wheel, double-spoke, shift paddles and steering wheel heating | R1,500 | R1,500 |
| 2PF | Sports contour leather-wrapped multi-function steering wheel, with shift paddles, 3-spoke, flat-bottomed | R2,300 | R2,300 |
| 2V9 | Air ionizer and aromatization Refreshing air quality, pleasant scent and improved purity. An atmosphere that you can feel. | R8,100 | R8,100 |
| GA2 | Comfort stationary air conditioning In addition to the standard stationery air conditioning, further equipment such as seat heating and window heating can be activated with comfort stationary air conditioning | R1,700 | R1,700 |
| 7E4 | Increased heat output Improve the charging ability of your Audi e-tron ¹ battery on cold days and use the possibility of heating the interior even more quickly in low outside temperatures. | R7,700 | R7,700 |
| VW0 | Acoustic glass for door and side windows | R10,100 | R10,100 |
| 3Y4 | Manual sunshade for the rear door windows | R4,000 | R4,000 |
| 5XF | Sun visor on driver and front passenger side, retractable | R1,100 | R1,100 |
| VT3 | Scuff plates with aluminum inserts in front and rear, illuminated | R3,600 | --- |
| 6SJ | Variably folding luggage compartment mat | R2,500 | R2,500 |
| UE8 | USB ports with charging function in rear | R3,100 | R3,100 |



| Optional equipment | | 55 advanced | 55 S line |
|------------------------------------|--|-------------|-----------|
| <u>Seats Upholstery Inlays</u> | | | |
| PS8 | Individual contour seats in front The customized contour seat offers a particularly comfortable seating experience and a wide range of adjustment options. The seat height, the fore / aft position, the seat and backrest inclination of the front seats and the 4-way lumbar support can be electrically adjusted to the individual needs of the driver and front passenger. | R50,700 | R50,700 |
| PV6 | Power seats in front including memory feature for both front seats | R25,400 | R25,400 |
| 4A4 | Seat heaters in front and rear | R7,700 | R7,700 |
| 4D8 | Seat ventilation and massage feature in front | R31,100 | R31,100 |
| 4D3 | Seat ventilation in front | R16,100 | R16,100 |
| Q1D | Sports seats in front | R12,900 | R12,900 |
| Q4Q | Sports seats Plus in front | R20,600 | R20,600 |
| 5ZC | Variable head restraints for front seats | R3,100 | R3,100 |
| 7HC | Upper part of dashboard in leather | R9,300 | R9,300 |
| 7HF | Upper part of dashboard in leather and lower interior elements in leatherette | R16,300 | R16,300 |
| 7HD | Upper part of dashboard and lower interior elements in leather | R21,100 | R21,100 |
| 7HM | Upper part of dashboard and lower interior elements in leatherette | R7,100 | R7,100 |



| Optional equipment | | 55 advanced | 55 S line |
|------------------------------------|--|-------------|-----------|
| Seats Upholstery Inlays | | | |
| N5K | Dinamica® microfiber "Frequenz"/leather combination with embossed "S" Dinamica Frequency microfibre is a breathable material with a sporty look. Includes: - seat centre panels of the front seats and of the two outer rear seats in Dinamica Frequency microfibre, black or rotor grey - seat side bolsters, head restraints, centre rear seat and centre armrest in leather, black or rotor grey with contrasting stitching - S embossing on the front seat backrests Only available with S line interior (WQS) | No cost | No cost |
| N5J | Dinamica® microfiber/leather combination Dinamica Frequency microfibre is a breathable material with a sporty look. Includes: · seat centre panels of the front seats and of the two outer rear seats in Dinamica microfibre, black or metropolis grey · seat side bolsters, head restraints, centre rear seat and centre armrest in leather, black or metropolis grey | No cost | No cost |
| N4M | Leather/leatherette "mono.pur 550" combination | --- | No cost |
| N5D | Valcona leather | R8,100 | R8,100 |
| N2R | Valcona leather with embossed "S" | R19,000 | R19,000 |
| N0K | Valcona leather/Milano leather combination, perforated | R8,100 | R8,100 |
| N0Q | Valcona leather/Milano leather combination, perforated, with piping | R8,100 | R8,100 |
| 5MI | Decorative inserts in Dark Brown Natural Sycamore | R11,100 | R11,100 |
| 5TG | Decorative inserts in Matte Brushed Aluminum, dark | R8,100 | R8,100 |
| 5MG | Decorative inserts in Natural Burr Walnut | R11,100 | R11,100 |
| 5MB | Decorative inserts in Volcano Gray Natural Fine Grain Ash | R11,000 | R11,000 |



| Optional equipment | | 55 advanced | 55 S line |
|--------------------------------------|--|-------------|-----------|
| Safety and Assistance systems | | | |
| PCZ | 360-degree cameras + Parking aid Plus with 360° display Assists with entering and exiting parking spaces and with manoeuvring forwards and backwards by providing acoustic signals and visual display with virtual driving path display. | R15,000 | R15,000 |
| 6K8 | Audi pre sense front Within system limits and depending on the situation and speed, Audi pre sense front can warn of imminent collisions and initiate suitable braking. The safety measures offered by Audi pre sense front include: · tensioning of the front and, if available, the outer rear seat belts · optimisation of the seat position · activation of the hazard warning lights to alert other road users · closing of the windows and the panoramic glass sunroof (if ordered) | R8,100 | R8,100 |
| KS1 | Head-up display The multicoloured head-up display is rich in contrast and projects driver information into the driver's direct field of view. It is highly visible and reduces distraction from the traffic. | R27,900 | R27,900 |
| 6I5 | Lane departure warning with emergency assist The system warns the driver if the lane marking is inadvertently crossed. Steering pulses help the driver stay in lane. The integrated emergency assist can warn the driver of critical situations and, if necessary, initiate safety measures, such as optimisation of the seat position, and, if available, place an emergency call | R7,100 | R7,100 |
| 9R1 | Night vision assistant | R43,200 | R43,200 |
| 7X5 | Park assist with parking aid plus The system detects suitable parking spaces. Precise steering manoeuvres actively support you when entering or exiting parking spaces. Depending on steering angle and lane, a visual display warns the driver of obstacles at the sides. | R8,400 | R8,400 |
| 4X9 | Audi pre sense rear package The package includes a selection of functions that increase the safety and comfort of occupants sitting on the rear seat bench. These include side airbags in the rear to supplement the front side airbags and the head airbag system. Both offer additional protection for rear passengers within system limits if required. Reversible rear seat belt tensioners supplement the reversible front seat belt tensioners contained in Audi pre sense basic. In addition to the measures included in Audi pre sense basic, the seat belts are tensioned early in response to emergency or evasive braking and when handling at the absolute limits of performance. This reduces the forward and lateral movement of the occupants in the rear. Illuminated belt buckles increase convenience for occupants and enhance the appearance of the interior with subtle, high-quality lighting. Searching around for the seat belt buckle in the dark has become a thing of the past. | R14,500 | R14,500 |
| 4X4 | Side airbags in front and rear and curtain airbag system For the outer seats of the second seat row, to supplement the side airbags, front and head airbag system | R8,900 | R8,900 |

Vehicle driver assistance and safety systems are not a substitute for attentive driving. Drivers retain full responsibility for providing the necessary inputs for safe control of the vehicle. System descriptions within this brochure are provided for information purposes only. System limitations and operational requirements apply.



| Optional equipment | | 55 advanced | 55 S line |
|---------------------------|---|-------------|-----------|
| Exterior equipment | | | |
| 3S1 | Aluminum roof rails | R8,100 | R8,100 |
| 3S2 | Black roof rails | R8,100 | R8,100 |
| 3FU | Panoramic glass sunroof | R30,000 | R30,000 |
| 1D2 | Trailer hitch | R15,900 | R15,900 |
| 1D8 | Trailer hitch preparation | R4,000 | R4,000 |
| VC2 | Garage door opener This radio-operated remote control is freely programmable. Users can customise the names given to touchscreen areas for operation. Up to eight different radio-controlled garage doors, exterior gates or security and lighting systems in total can be stored. When approaching the stored location, a relevant pop-up appears to trigger the transmit operation. A user-friendly set-up assistant for the system – complete with the relevant owner’s manual information – is available via the MMI. | R5,000 | R5,000 |
| GZ2 | Power latching for doors | R12,900 | R12,900 |
| PC2 | Brake calipers painted in Orange (18-inch) | R8,100 | R8,100 |
| Charging systems | | | |
| 73Q | Industrial cable for 3-phase 32A (replaces 73N for 1-phase) | No cost | No cost |
| 73P | Industrial cable for 3-phase 16A (replaces 73N for 1-phase) | No cost | No cost |
| NW2 + KB4 + JS1 | AC charging at 22kW, includes: e-tron charging system "connect" up to 22 kW, On-board charger up to 22 kW (AC), Second charging access | R55,100 | R55,100 |



Important information

Welcome to Audi

Audi Freeway Plan | Motoring Peace of Mind

There can be no better motoring peace of mind than knowing that your car will be serviced, maintained and repaired, should this prove necessary, at no cost to you. Thanks to Audi Freeway Plan, that peace of mind could be yours.

The Audi Freeway Plan absorbs all maintenance and service costs, with the exception of between-service top-up fluids, fuel, cracked or broken glass, and tyres.

A five-year or 100 000 km Audi Freeway Plan is included as standard on all new Audi vehicles.

Top-up options to extend maintenance up to 10 years, or 300 000 km are available at extremely competitive rates. Audi has specially designed the Audi Freeway Plan for easy operation on the part of the owner. Making an appointment with any one of our approved Audi Servicing Dealers can effect regular servicing and maintenance as well as repairs (with the exception of accident damage).

All work is handled by the relevant service department, which will liaise directly with the Audi Freeway Plan Maintenance Unit. No extra effort or payment is required from the Audi owner. The Audi Freeway Plan is registered with the vehicle and as such is transferable to the new owner should the car be sold before the Audi Freeway Plan has expired, giving added resale value. The Audi Freeway Plan is available in addition to the Audi's standard one-year/unlimited distance vehicle warranty. The Audi Freeway Plan is subject to certain exclusions, covers any repairs necessary after the expiry of the standard warranty.

Audi Assist | Emergency and Personal Assistance

Audi Assist is a programme whereby Audi of South Africa and its Dealer Network pledge to provide you with peace of mind motoring by providing the infrastructure to support a countrywide emergency service 24 hours a day, every day.

The programme is known as Audi Assist and operates within the borders of South Africa as well as Namibia and Botswana. The objective of the programme is to ensure on the spot roadside assistance offered by a fully equipped and trained Audi technician.

The primary focus is to get you mobile in your own vehicle. Where a roadside repair cannot be effected and the vehicle needs to be towed to the nearest Audi dealer, you and the occupants of the vehicle will be transported to a place of safety in the dealer's roadside assistance vehicle.

Contact details within South Africa:

086 043 4838

Contact details for neighbouring states:

+27 41 994 5616

24 hours a day, 7 days a week

Vehicle model and VIN number will be required.

Audi e-tron Dimensions

All the measurements you need

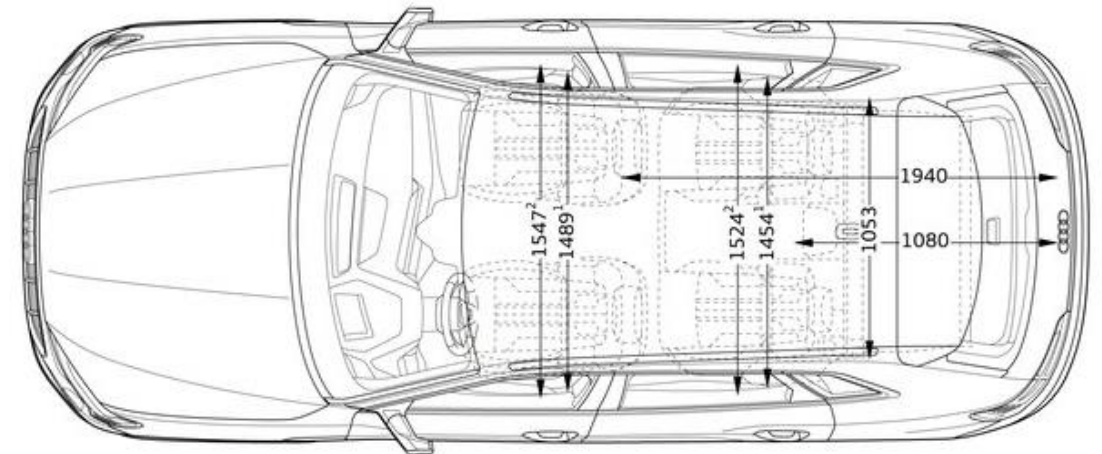
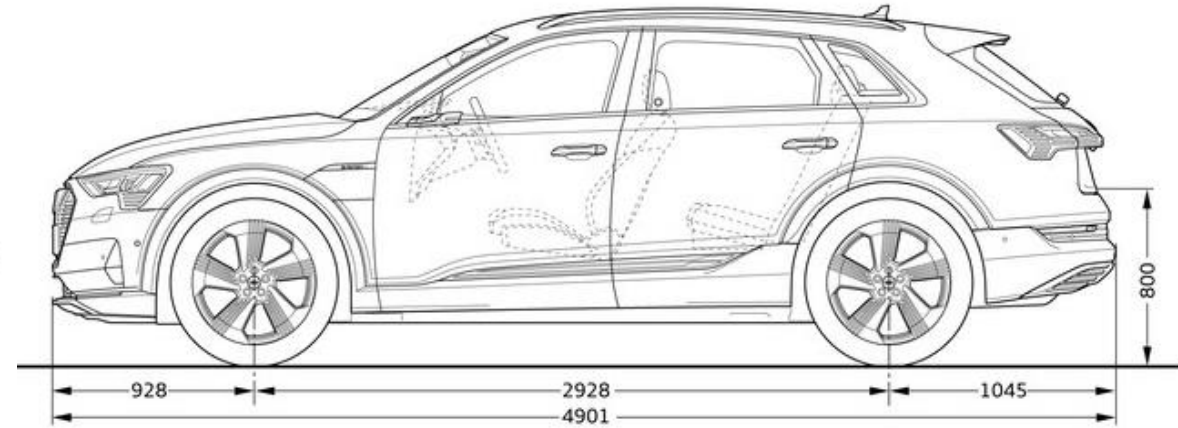
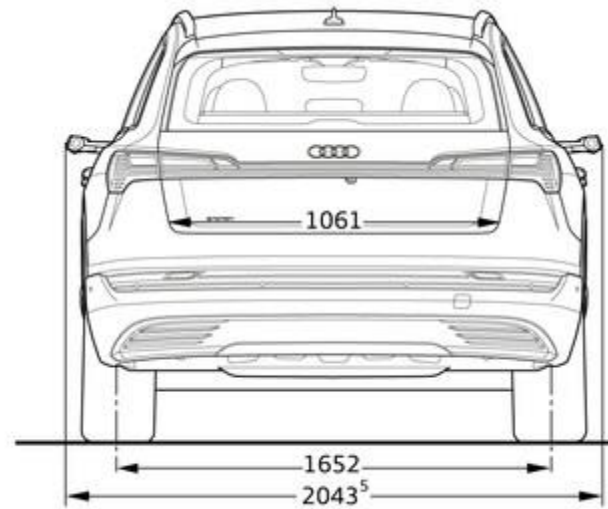
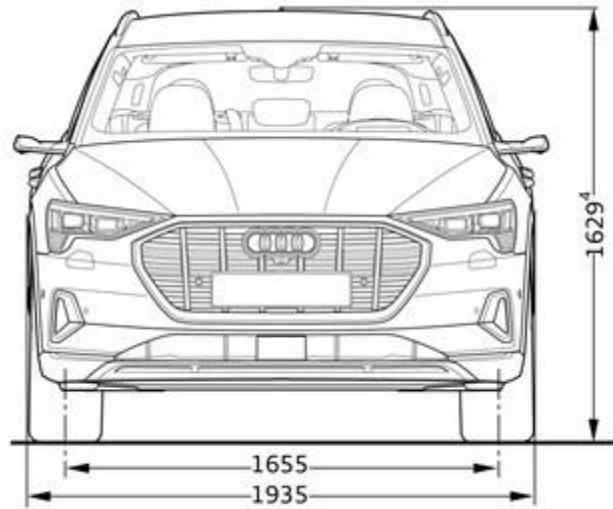

¹Width shoulder space
²Width elbow space
³Maximum head space
⁴Vehicle height with roof antenna
⁵Vehicle width with exterior mirror +146 mm
Data in millimetres

Audi e-tron luggage compartment capacity – 660/1725 l

e-tron



Information in this pricelist

We've done all we can to make the prices, specifications, technical details and all other information you see in this pricelist accurate at the time of publication. We reserve the right to change prices or specification at any time. All prices shown include VAT, which is currently charged at 15%. Recommended retail pricing is not binding and is inclusive of a 5 year/100,000km Audi Freeway Plan.

Please check model availability and full specification details with your Audi Dealership prior to ordering. Neither Audi South Africa nor Audi Dealers can accept contractual responsibility for your reliance on the information contained in this pricelist. Performance figures and specifications relating to Audi vehicles are indicative only and performance cannot be guaranteed. Performance figures and specifications may be updated from time to time, when new test results or other information become available. Your local Audi Dealership can always provide you with the most up-to-date information available. Written and visual depictions (including photographs) of vehicles, are for illustrative purposes only and should not be relied upon. Some illustrations may not accurately reflect South African specifications (including paint and trim colours) and may not be available. If in doubt, always contact your local Audi Dealership.